

型名 Type Number	F4066
定格 Rating	20A

一般公差 / General Tolerance ±0.5

尺度 / Scale 1/1 単位 / Unit mm

基板加工例
Processing the printed board

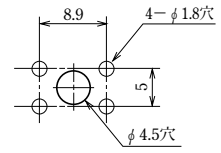

プリント基板厚 t 1.4~2.0
Printed board: t 1.4~2.0

- 注文方法：型番 (下表の型番を御参照下さい)
- Ordering Form : Type No. (See the type number in the following table)

■仕様 / Specifications.

部番 / Part No.	名称 / Part Name	材質 / Material	寸法 / Size	規格 / Standard	処理 / Treatment
1	基板端子 Printed board terminal	黄銅 Brass	板厚 t 0.8	C2680R	スズメッキ Tin-Plated
2	結線ビス Screw	黄銅 Brass		C2700W	ニッケルメッキ Nickel-Plated

型番 / Type No.	納入される物 / Product Delivered
F4066C	基板端子 (M4用) のみ (ビスなし) / Printed board terminal (for M4) only (w/o screws)
F4066C S	基板端子+M4×6L バインドビス組付 / Printed board terminal+M4×6L binding head screw attached

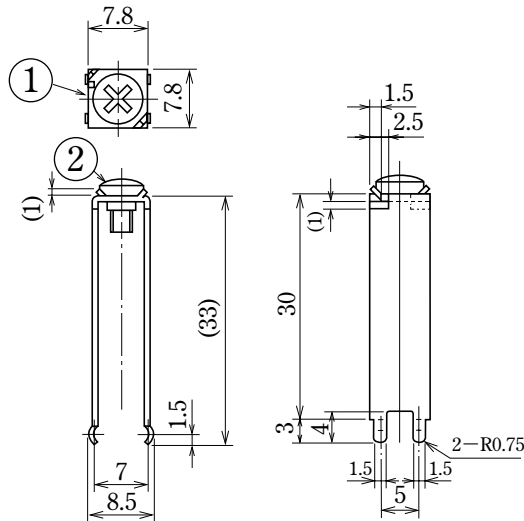

型名 Type Number	F4069
定格 Rating	20A

一般公差 / General Tolerance ±0.5

尺度 / Scale 1/1 単位 / Unit mm

基板加工例
Processing the printed board

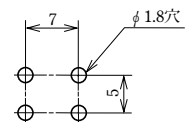

プリント基板厚 t 1.4~2.0
Printed board: t 1.4~2.0

- 注文方法：型番 (下表の型番を御参照下さい)
- Ordering Form : Type No. (See the type number in the following table)

■仕様 / Specifications.

部番 / Part No.	名称 / Part Name	材質 / Material	寸法 / Size	規格 / Standard	処理 / Treatment
1	基板端子 Printed board terminal	黄銅 Brass	板厚 t 0.8	C2680R	スズメッキ Tin-Plated
2	結線ビス Screw	黄銅 Brass		C2700W	ニッケルメッキ Nickel-Plated

型番 / Type No.	納入される物 / Product Delivered
F4069A	基板端子 (M3用) のみ (ビスなし) / Printed board terminal (for M3) only (w/o screws)
F4069A S	基板端子+M3×6L バインドビス組付 / Printed board terminal+M3×6L binding head screw attached