

ピッチ/Pitch 9.6mm

型名 Type Number	F2147
定格 Rating	20A

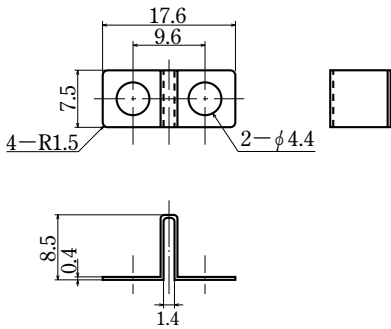

ピッチ/Pitch 36mm

型名 Type Number	F2149
定格 Rating	100A

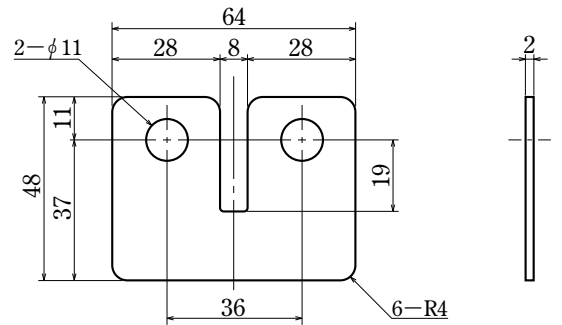
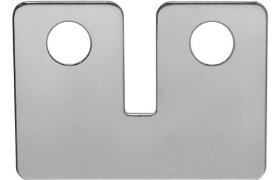

ピッチ/Pitch 8.7mm

型名 Type Number	F2150
定格 Rating	15A

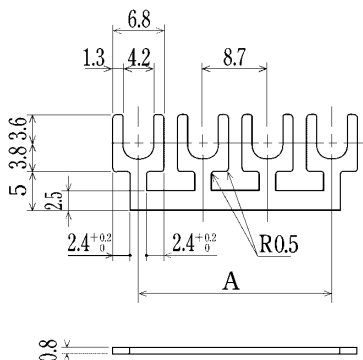
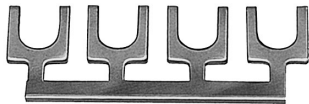

極数/Poles	2P	3	4	5	6	7	8
A	8.7	17.4	26.1	34.8	43.5	52.2	60.9

- 注文方法：型名
- Ordering Form : Type No.

■仕様/Specifications.

材質/Material	規格/Standard	処理/Treatment	備考/Remark
黄銅 Brass	C2680R	ニッケルメッキ Nickel-Plated	

ピッチ/Pitch 27mm

型名 Type Number	F2151
定格 Rating	100A

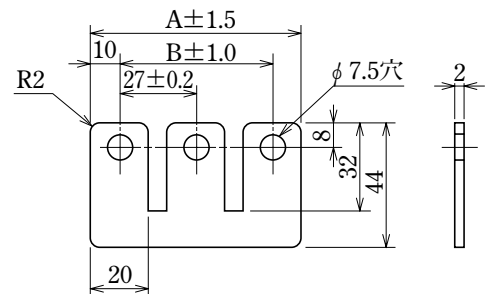
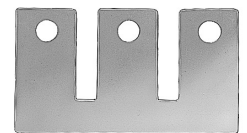

極数/No. of Poles	2P	3	4	5	6	7
A	47	74	101	128	155	182
B	27	54	81	108	135	162