

Conforms to IEC 61076-4-101 Standard
2mm Pitch Hard Metric 2 Piece Connector

CP SERIES

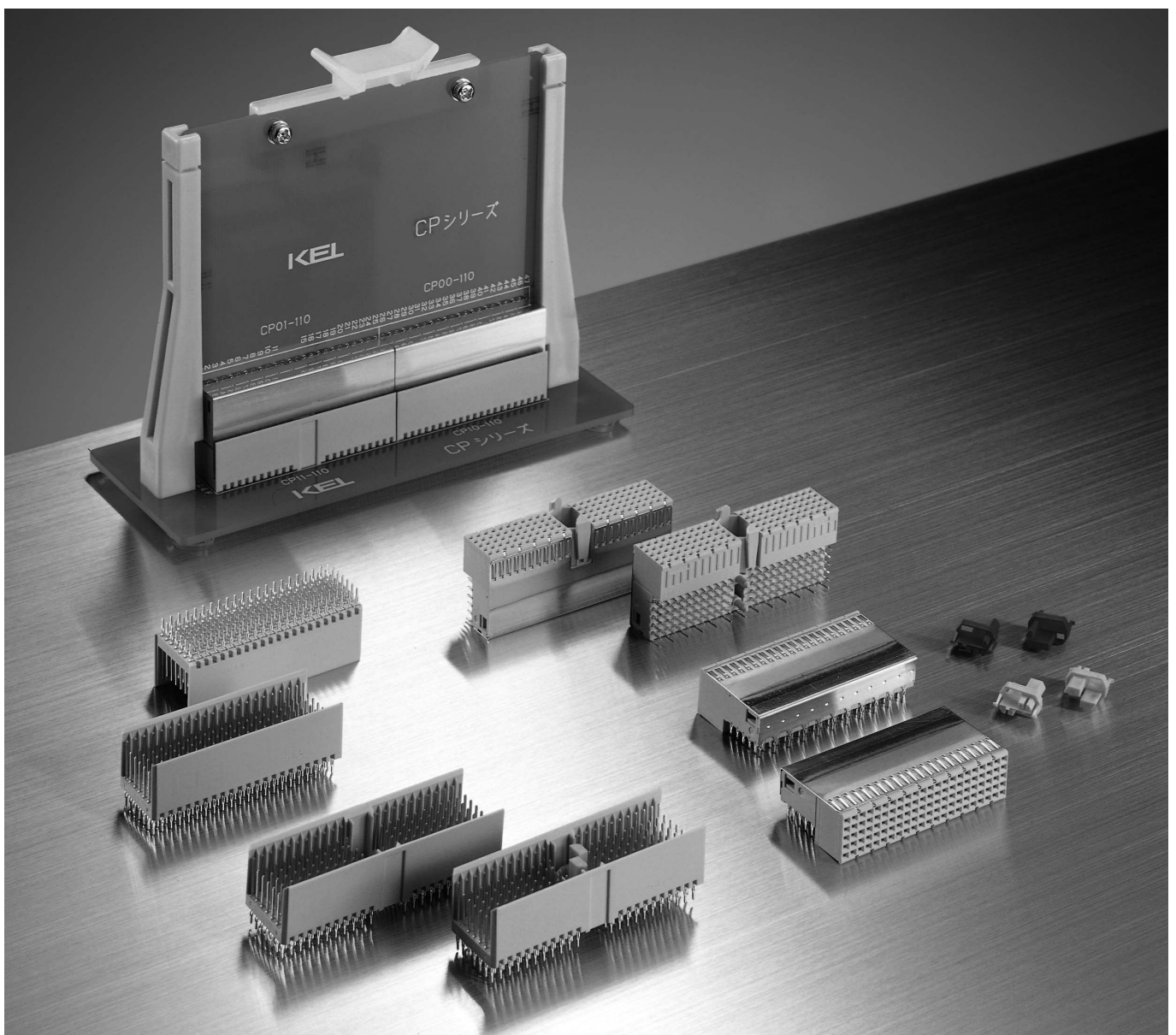

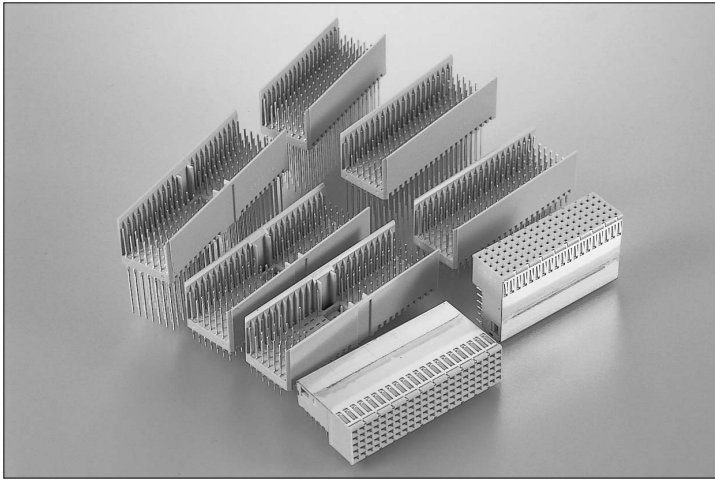

FEATURES

- Conforms to IEC 61076-4-101 standard
- Connectors for CompactPCI bus
- High density connection
- High speed transmission and EMI protection
- Applicable to "Hot Plug" (Sequenced mating)
- Highly reliable press-fit mounting
- A computer telephony support connector is available
- Highly reliable contacts with 2 mating points for Receptacles
- Available backplane assemblies and rack systems
- RoHS compliance

SPECIFICATIONS

- Insulator material : Glass-filled PBT
(UL 94V-0), Gray
- Contact material : Copper alloy
- Contact plating :
Contact area; Gold over Nickel
Terminal area; Gold over Nickel
- Shield plate material: Copper alloy
- Shield plate plating :
Contact area; Gold over Nickel
Terminal area; Gold over Nickel
- Shroud material : Glass-filled PBT(UL 94V-0), Gray
- Current rating : 1A per contact
- Contact resistance : 30mΩ max.
- Dielectric withstanding voltage : 750V AC for 1 minute
- Insulation resistance : 10,000MΩ min. at 100V DC
- Operating temperature : -55 °C to +125 °C

[APPLICATIONS]

•Process controllers, Power plant systems, Industrial computing, Semiconductor processing units, Telecommunications, Measuring equipment, Medical equipment, Aerospace, Other industrial equipment, etc.

[KEL'S SPECIAL FEATURES]

•KEL is able to provide backplane assembly products (Connectors are pre-mounted on board) to decrease the customer's assembly processes, as KEL operates a backpanel business.
Please contact your local sales office for more information.

•KEL also can supply optional connector installation tools, please refer to page I-16.

ORDER CODE

CP0 - - - - **1** - **F**

- **F** : RoHS Compliance
- Plating of contact area
Omit : Au 0.1μm min. (Standard)
H : Au 0.76μm min.
- Shield plate
1 : With shield plate
95 pin : 19 shield contacts
110 pin : 22 shield contacts
- Number of contacts
095 : 95 pin **110** : 110 pin
- Variation
00 : Receptacle Without guide lug and space for key (Type B)
01 : Receptacle With guide and space for key (Type A, 110 pin only)
- Series name
CP : 2mm pitch hard metric 2 piece connector

CP1 - - - - - **F**

- **F** : RoHS Compliance
- Plating of contact area
Omit : Au 0.1μm min. (Standard)
H : Au 0.76μm min.
- Ground contact
1 : With ground contact
2 : Without ground contact
3 : Hot Swap (Type A, 110 pin)
4 : Computer Telephony (Type A, 84 pin and Type B, 110 pin)
- Terminal length
P2 : 3.7mm (0.146")
R : 16mm (0.630")
- Number of contacts
055 : 55 pin **084** : 84 pin (Computer Telephony only)
095 : 95 pin **110** : 110 pin
125 : 125 pin
- Variation
10 : Plug without guide slot and space for key (Type B)
11 : Plug with guide slot and space for key (Type A, 110 pin only)
12 : Plug (Type C, 55 pin only)
- Series name
CP : 2mm pitch hard metric 2 piece connector

CP00-□□□-1□-F (Receptacle, Type B)

Mating Connector : CP10-□□□-P2-1□-F

Unit:mm(inch)

Receptacle, Type B

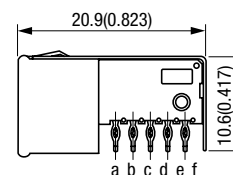
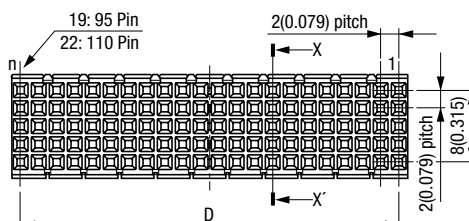
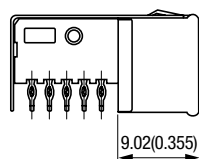
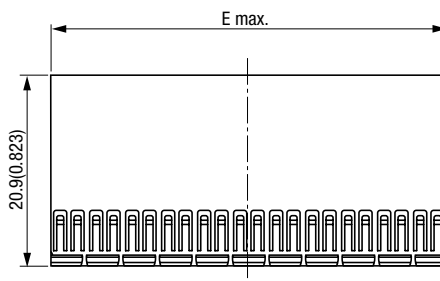
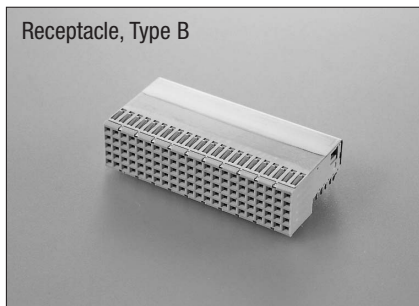

X-X' Cross Section

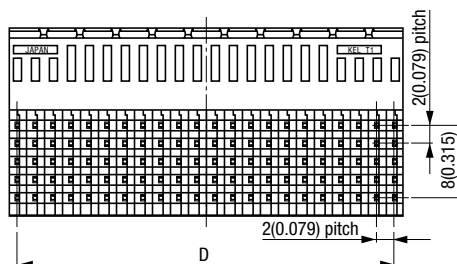
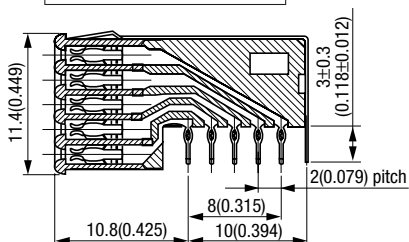

Printed Circuit Board Layout (Component Side View)

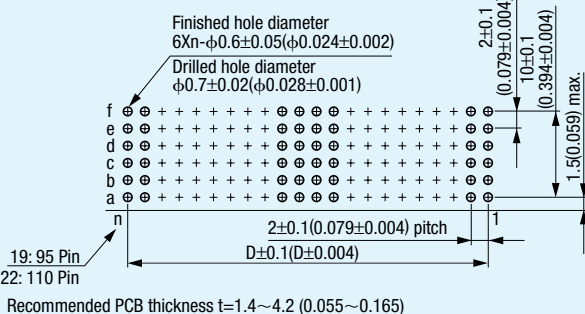

Packaging style
Pipe

Product Table / Dimensions

No. of contacts	Part Number	D	E	Number of packaging
95	CP00-095-1□-F	36.00 (1.417)	37.90 (1.492)	13
110	CP00-110-1□-F	42.00 (1.654)	43.90 (1.728)	11

Row "f" odd numbers : For upper ground return shield
 Row "f" even numbers : For lower ground return shield (future option)

CP01-110-1□-F (Receptacle, Type A)
Mating Connector : CP11-110-P2-1□-F

Unit:mm(inch)

Receptacle, Type A

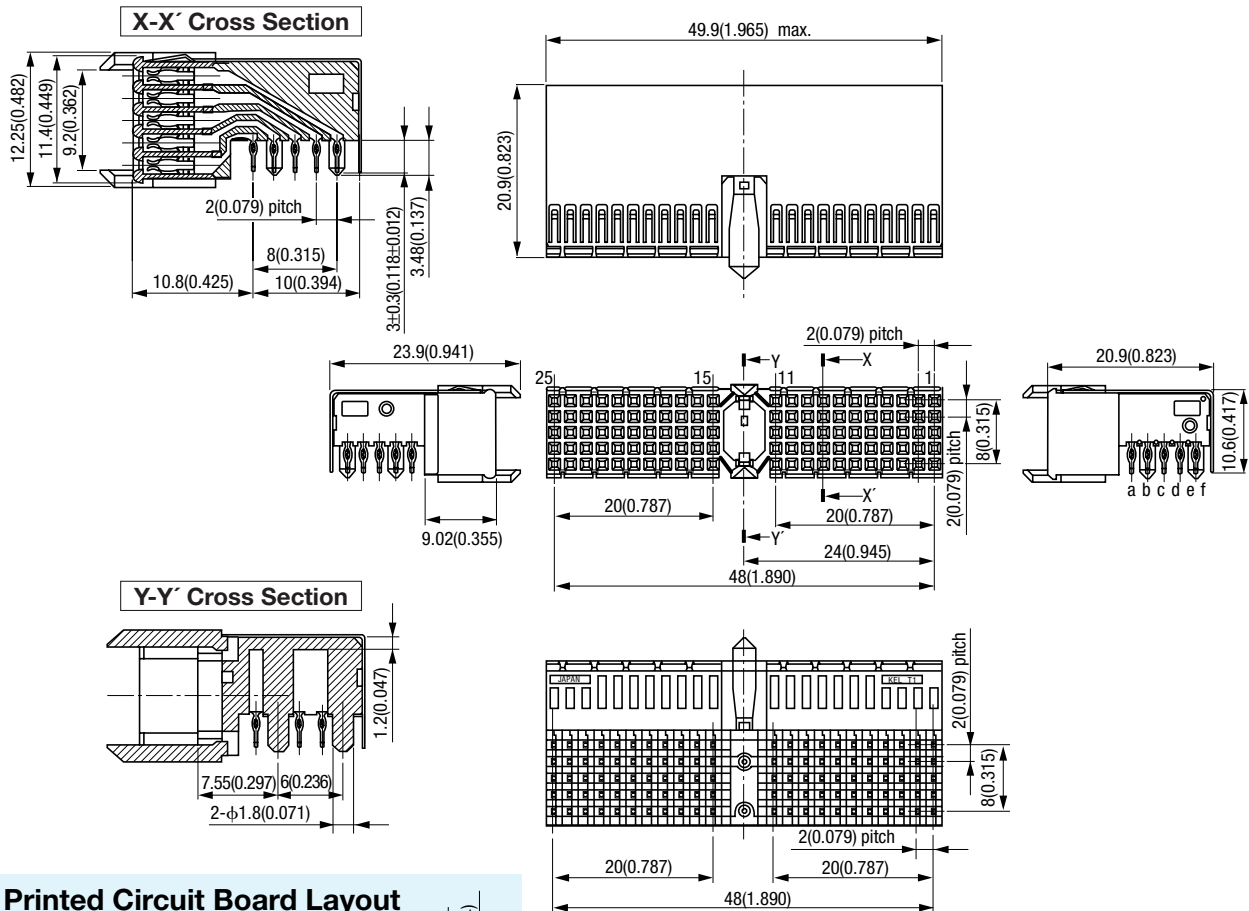
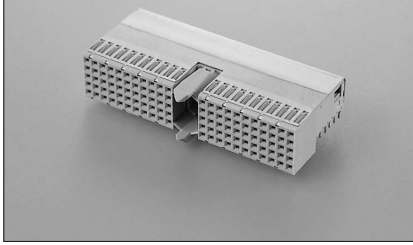
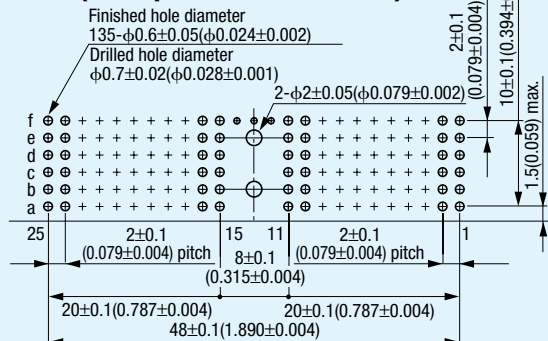
Printed Circuit Board Layout (Component Side View)

Recommended PCB thickness t=1.4~4.2 (0.055~0.165)

 Row "f" odd numbers : For upper ground return shield
 Row "f" even numbers : For lower ground return shield (future option)

Packaging style
Pipe

Product Table

No. of contacts	Part Number	Number of packaging
110	CP01-110-1□-F	10

CP10-□□□-P2-1□-F (Plug, Type B)

Mating Connector : CP00-□□□-1□-F

Unit:mm(inch)

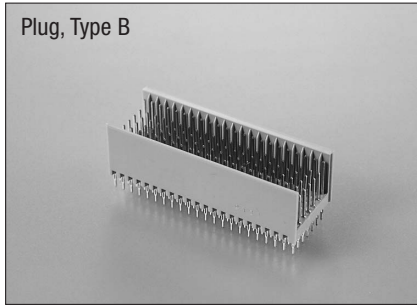

Plug, Type B

X-X' Cross Section

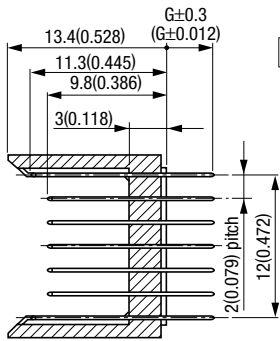

Contact Dimension

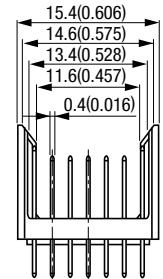
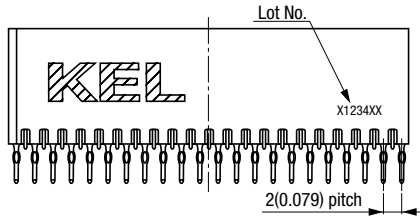
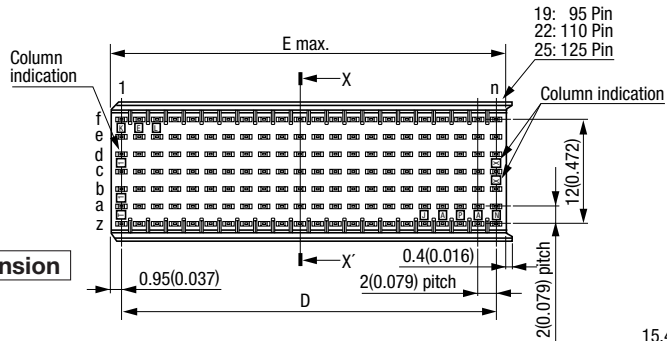
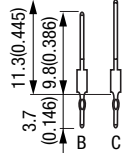

Layout for Different Contact Levels

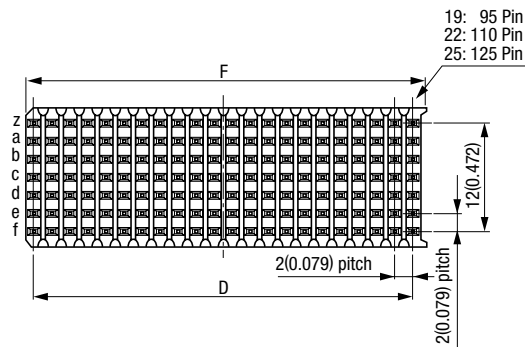
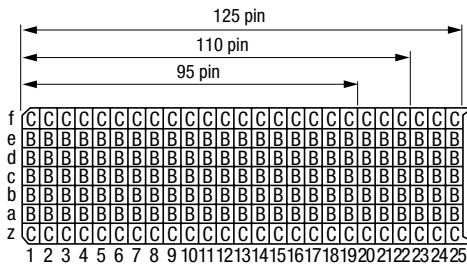

* For B and C contact levels, please refer to "Contact Dimension".

Printed Circuit Board Layout (Component Side View)

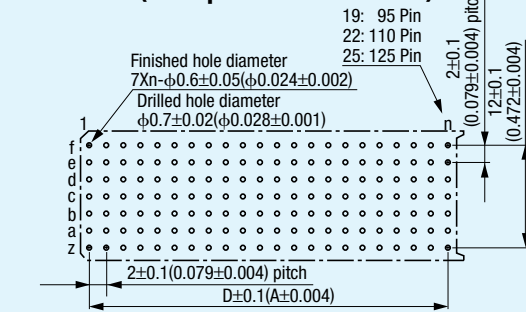

Recommended PCB thickness t=1.4~5.6(0.055~0.220)

Packaging style
Pipe

Product Table / Dimensions

No. of contacts	Part Number	D	E	F	Number of packaging
95	CP10-095-P2-1□-F	36.00 (1.417)	37.85 (1.490)	38.25 (1.506)	13
110	CP10-110-P2-1□-F	42.00 (1.654)	43.85 (1.726)	44.25 (1.742)	11
125	CP10-125-P2-1□-F	48.00 (1.890)	49.85 (1.963)	50.25 (1.978)	10

Terminal length	G
P2	3.7 (0.146)

Rows "z" and "f" : For ground return shield contacts

CP11-110-P2-1□-F (Plug, Type A)

Mating Connector : CP01-110-1□-F

Unit:mm(inch)

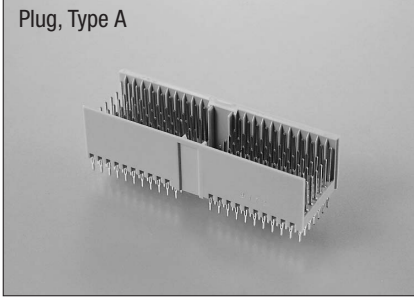

X-X' Cross Section

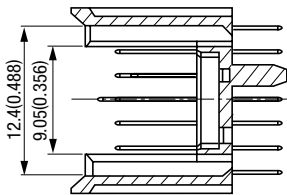

Y-Y' Cross Section

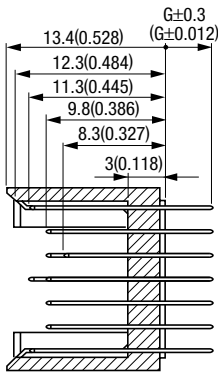

Contact Dimension

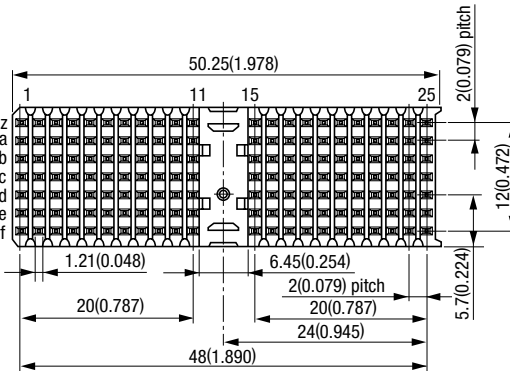
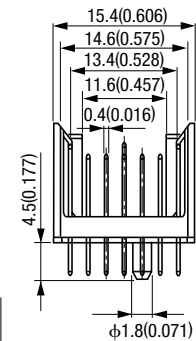
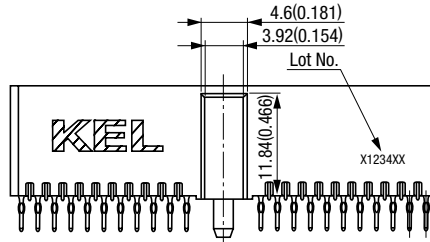
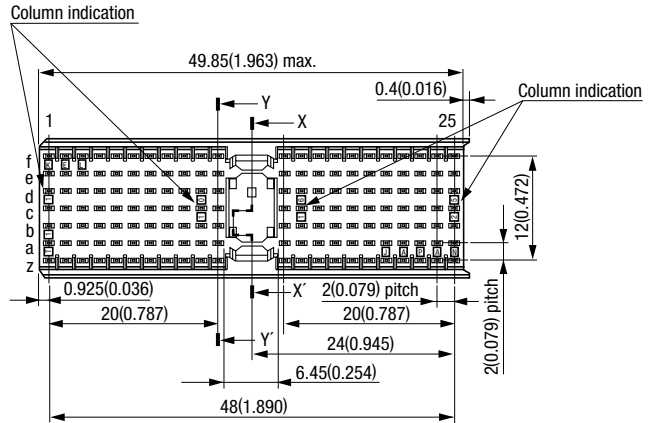
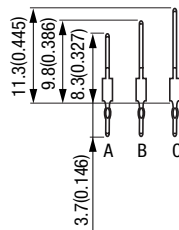

Printed Circuit Board Layout (Component Side View)

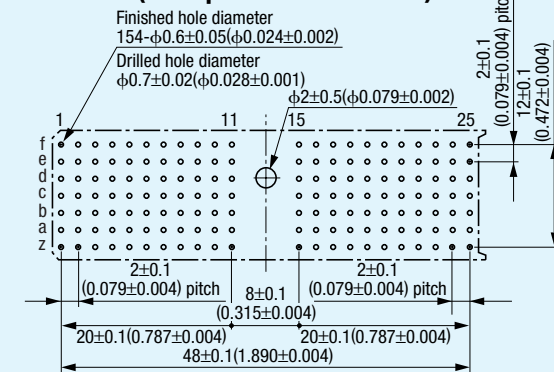

Layout for Different Contact Levels

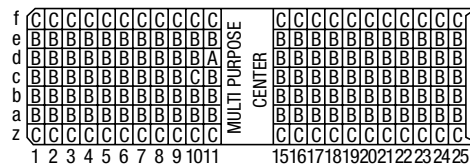

* For A, B and C contact levels, please refer to "Contact Dimension".

Product Table

No. of contacts	Part Number	Number of packaging
110	CP11-110-P2-1□-F	10

Packaging style
Pipe

Terminal length	G
P2	3.7 (0.146)

Rows "z" and "f": For ground return shield contacts

CP12-055-P2-1□-F (Plug, Type C)

Unit:mm(inch)

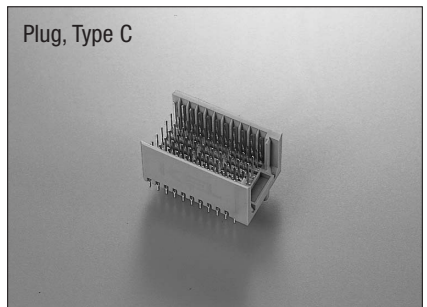

Plug, Type C

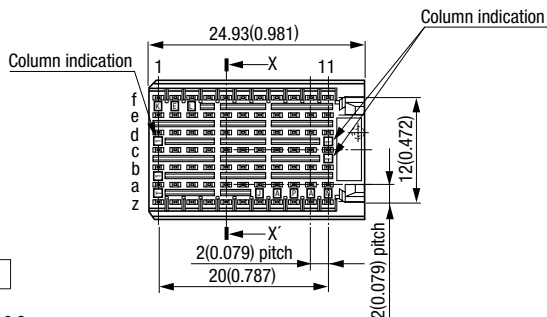

X-X' Cross Section

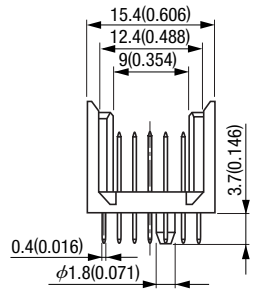
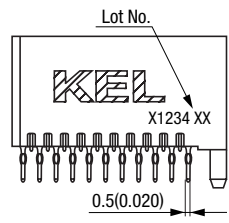
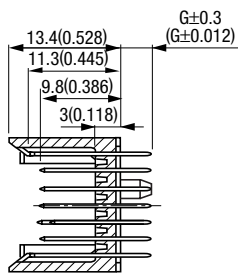

Contact Dimension

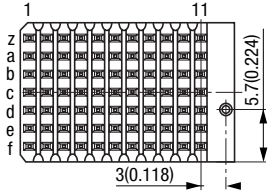
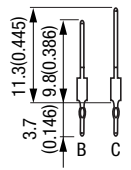

Printed Circuit Board Layout (Component Side View)

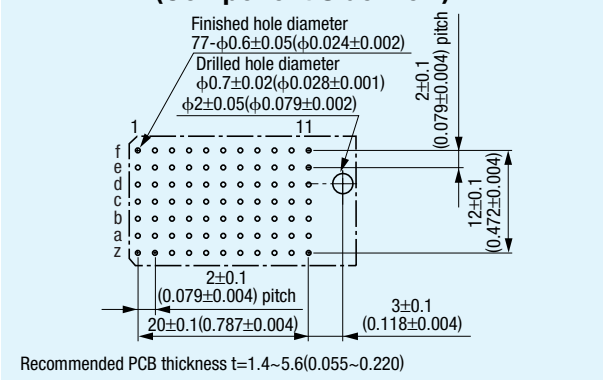

Layout for Different Contact Levels

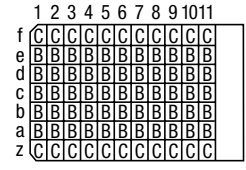

* For B and C contact levels, please refer to "Contact Dimension".

Packaging style
Pipe

Product Table

No. of contacts	Part Number	Number of packaging
55	CP12-055-P2-1□-F	20

Terminal length	G
P2	3.7 (0.146)

Rows "z" and "f": For ground return shield contacts

CP10-□□□-R-1□ (Plug, Tail Length 16mm, Type B)

Unit:mm(inch)

Plug, Type B (Long Tail)

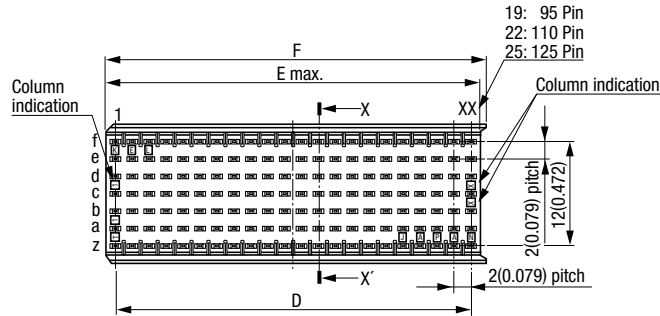
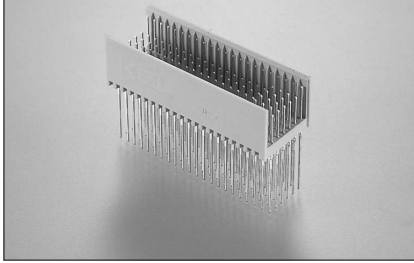

X-X' Cross Section

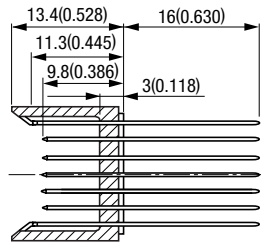

Contact Dimension

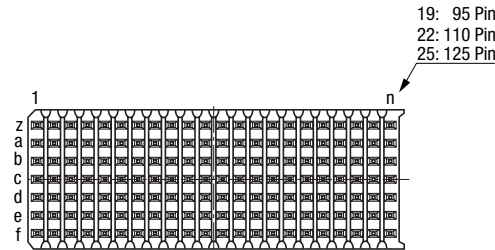
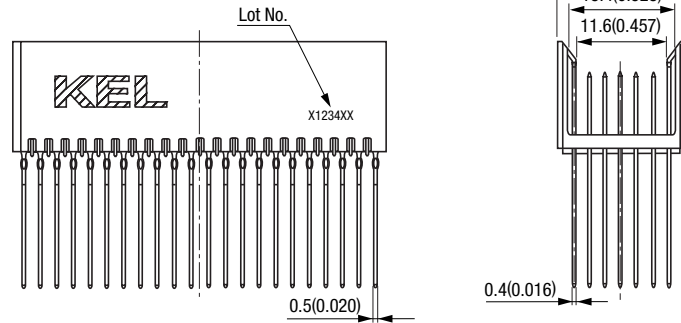
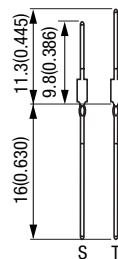

Layout for Different Contact Levels

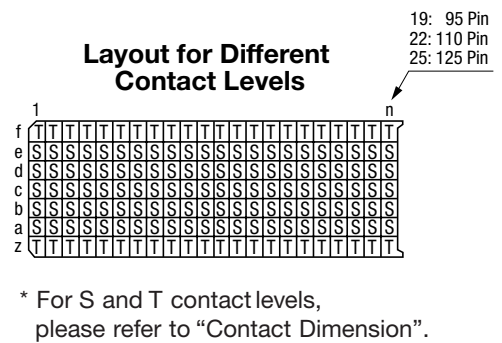

Printed Circuit Board Layout (Component Side View)

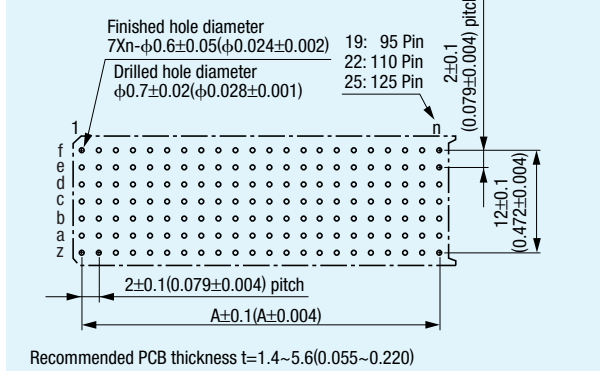

Rows "z" and "f": For ground return shield contacts

Packaging style
Pipe

Product Table / Dimensions

No. of contacts	Part Number	D	E	F	Number of packaging
95	CP10-095-R-1□	36.00 (1.417)	37.85 (1.490)	38.25 (1.506)	13
110	CP10-110-R-1□	42.00 (1.654)	43.85 (1.726)	44.25 (1.742)	11
125	CP10-125-R-1□	48.00 (1.890)	49.85 (1.963)	50.25 (1.978)	10

CP12-055-R-1□ (Plug, Tail Length 16mm, Type C)

Unit:mm(inch)



Plug, Type C (Long Tail)

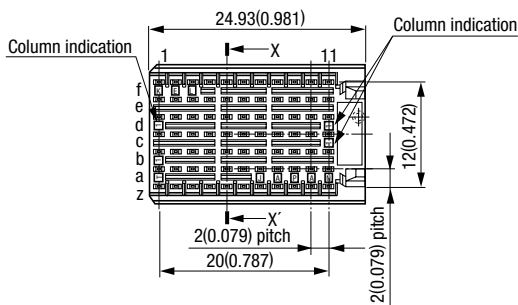

X-X' Cross Section

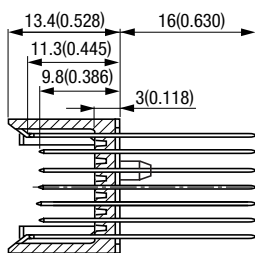

Contact Dimension

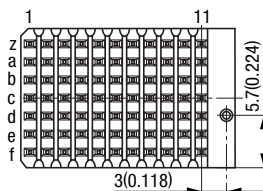
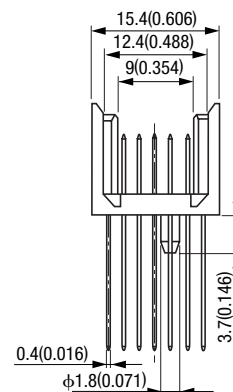
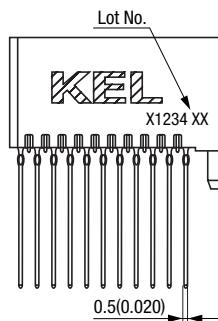
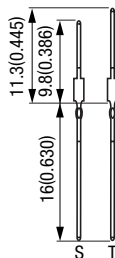

Layout for Different Contact Levels

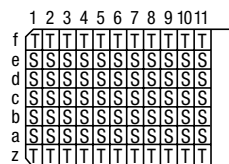

* For S and T contact levels, please refer to "Contact Dimension".

Printed Circuit Board Layout (Component Side View)

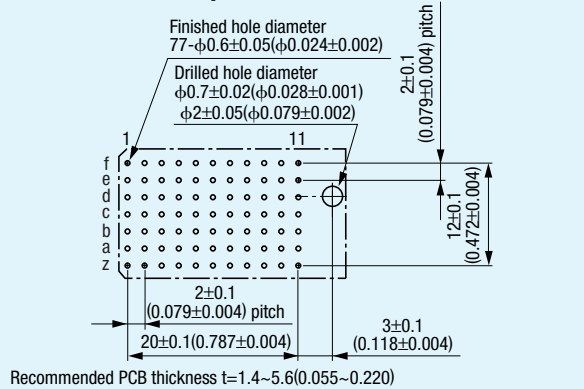

Rows "z" and "f": For ground return shield contacts

Packaging style
Pipe

Product Table

No. of contacts	Part Number	Number of packaging
55	CP12-055-R-1□	20

CP10-110-R-4 (Plug, Tail Length 16mm, Computer Telephony, Type B)

Plug, Type B (Long Tail, Computer Telephony)

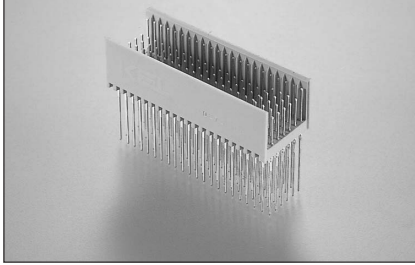

Unit:mm(inch)

X-X' Cross Section

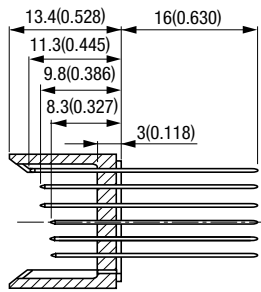

Contact Dimension

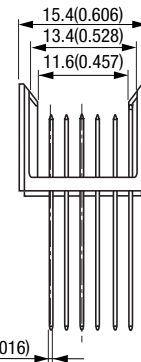
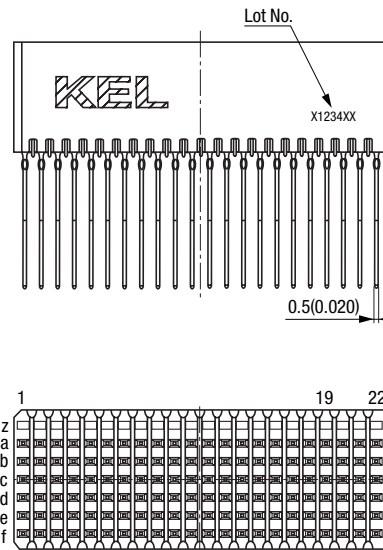
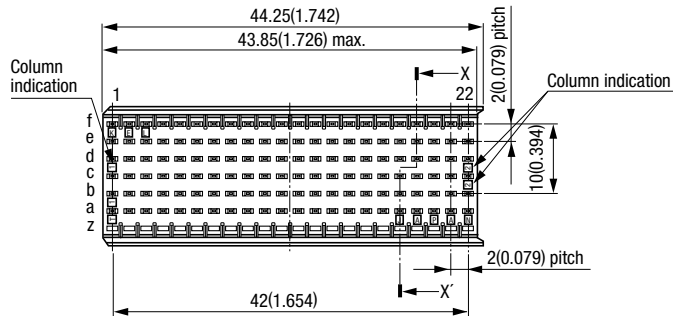
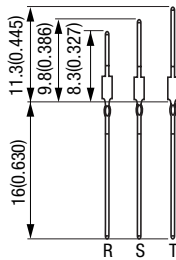

Layout for Different Contact Levels

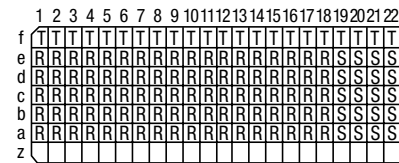

* For R, S and T contact levels, please refer to "Contact Dimension".

Printed Circuit Board Layout (Component Side View)

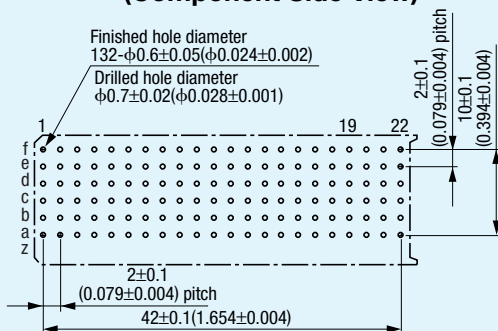

Recommended PCB thickness t=1.4~5.6(0.055~0.220)

Row "f": For ground return shield contacts

Packaging style
Pipe

Product Table

No. of contacts	Part Number	Number of packaging
110	CP10-110-R-4□	11

CP11-110-R-1 (Plug, Tail Length 16mm, Type A)

Unit:mm(inch)

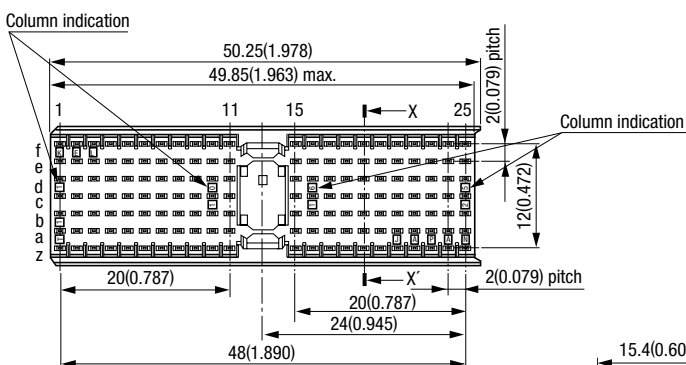
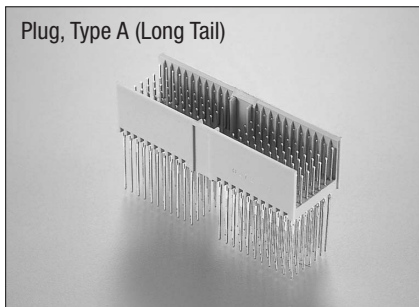

X-X' Cross Section

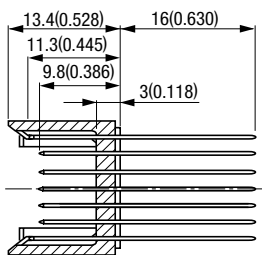

Contact Dimension

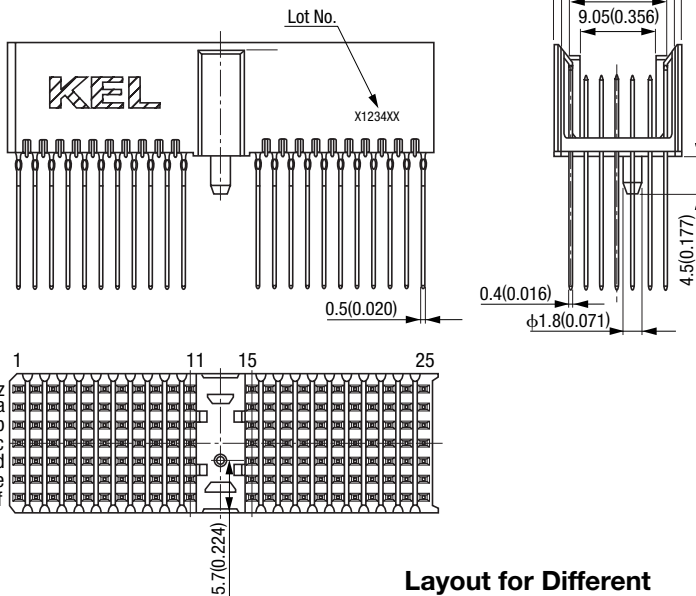
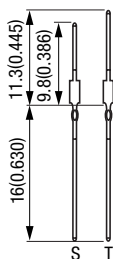

Layout for Different Contact Levels

	1	2	3	4	5	6	7	8	9	10	11	15	16	17	18	19	20	21	22	23	24	25	
f	T	T	T	T	T	T	T	T	T	T	T	T	T	T	T	T	T	T	T	T	T	T	T
e	S	S	S	S	S	S	S	S	S	S	S	S	S	S	S	S	S	S	S	S	S	S	S
d	S	S	S	S	S	S	S	S	S	S	S	S	S	S	S	S	S	S	S	S	S	S	S
c	S	S	S	S	S	S	S	S	S	S	S	S	S	S	S	S	S	S	S	S	S	S	S
b	S	S	S	S	S	S	S	S	S	S	S	S	S	S	S	S	S	S	S	S	S	S	S
a	S	S	S	S	S	S	S	S	S	S	S	S	S	S	S	S	S	S	S	S	S	S	S
z	T	T	T	T	T	T	T	T	T	T	T	T	T	T	T	T	T	T	T	T	T	T	T

* For S and T contact levels, please refer to "Contact Dimension".

Printed Circuit Board Layout (Component Side View)

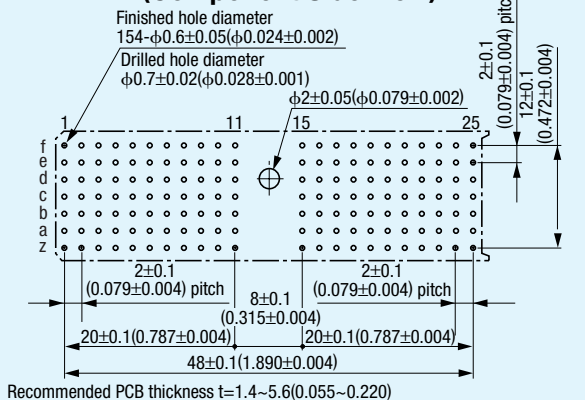

Rows "z" and "f": For ground hole return shield contacts

Packaging style
Pipe

Product Table

No. of contacts	Part Number	Number of packaging
110	CP11-110-R-1□	10

CP11-110-P2-3-F (Plug, Hot Swap, Type A)

Unit:mm(inch)

Plug, Type A (Hot Swap)

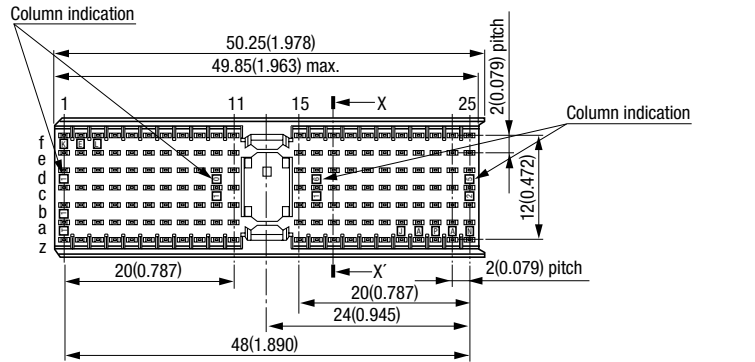
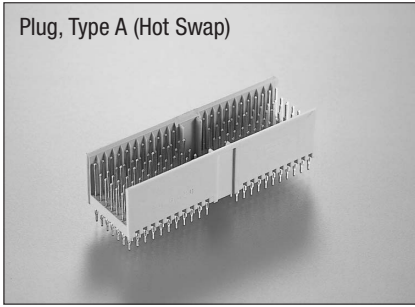

X-X' Cross Section

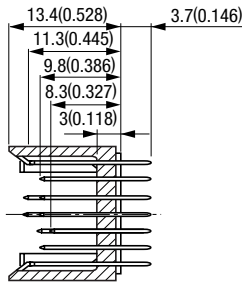

Contact Dimension

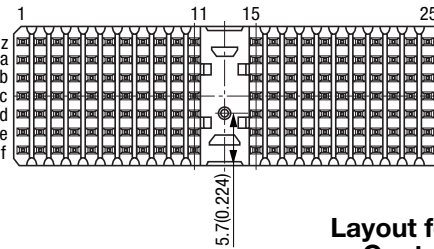
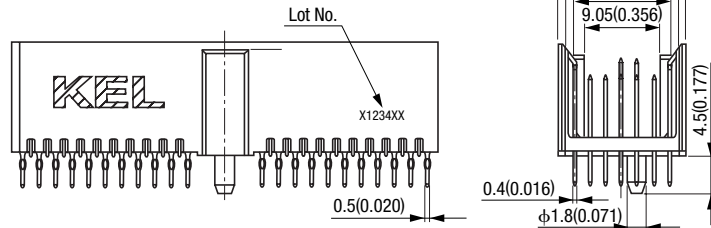
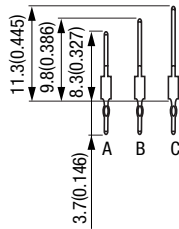

Layout for Different Contact Levels

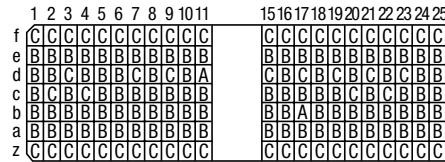

* For A, B and C contact levels, please refer to "Contact Dimension".

Printed Circuit Board Layout (Component Side View)

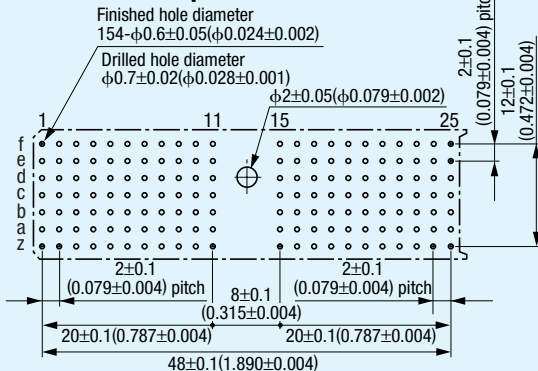

Recommended PCB thickness t=1.4~5.6(0.055~0.220)

Rows "z" and "f": For ground return shield contacts

Packaging style
Pipe

Product Table

No. of contacts	Part Number	Number of packaging
110	CP11-110-P2-3□-F	10

CP11-084-P2-4-F (Plug, Computer Telephony, Type A)

Unit:mm(inch)

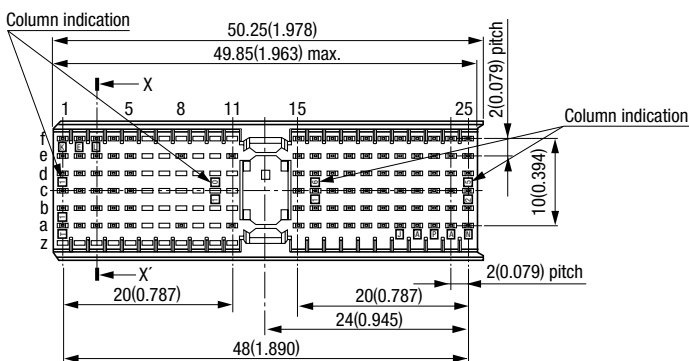
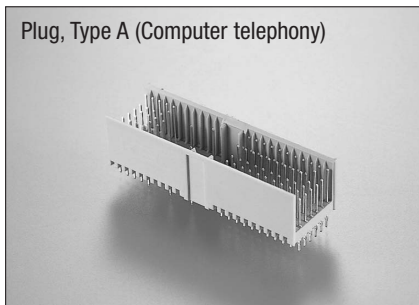

X-X' Cross Section

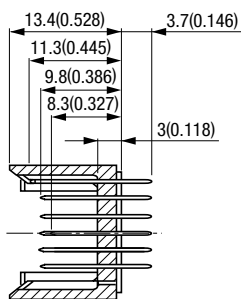

Contact Dimension

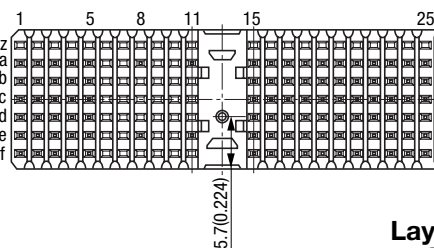
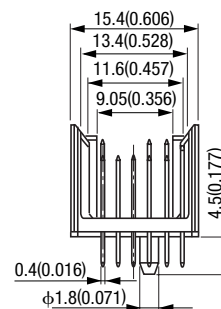
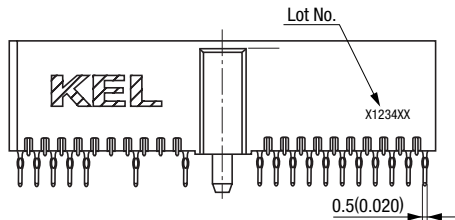
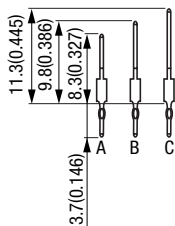

Layout for Different Contact Levels

	1	2	3	4	5	6	7	8	9	10	11	15	16	17	18	19	20	21	22	23	24	25	
f	C	C	C	C	C							C	C	C	C	C	C	C	C	C	C	C	C
e	B	B	B	B	C			B			C	B	B	B	B	B	B	B	B	B	B	B	B
d	B	B	B	B	B							C	C	C	C	C	C	C	C	C	C	B	B
c	B	B	A	B	B							B	B	B	B	B	B	B	B	B	B	B	B
b	B	B	B	B	B							B	B	B	B	B	B	B	B	B	B	B	B
a	B	B	B	B	C			B			C	B	B	B	B	B	B	B	B	B	B	B	B
z																							

* For A, B and C contact levels, please refer to "Contact Dimension".

Printed Circuit Board Layout (Component Side View)

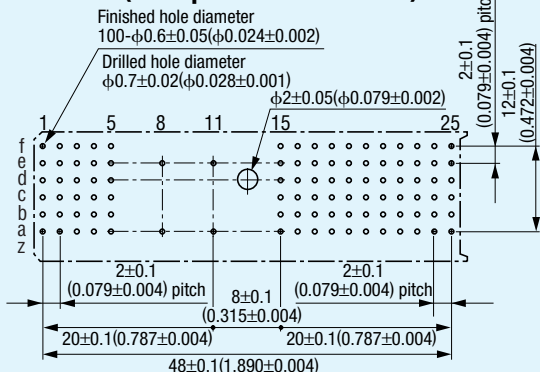

Recommended PCB thickness t=1.4~5.6(0.055~0.220)

Row "f": For ground return shield contacts

Packaging style
Pipe

Product Table

No. of contacts	Part Number	Number of packaging
84	CP11-084-P2-4-F	10

CP10S-□□□-41 (Shroud, Type B)

Shroud, Type B

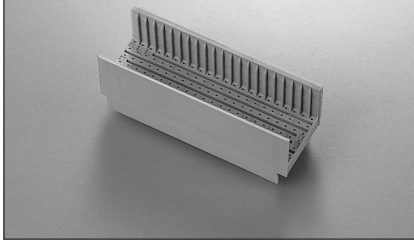
ORDER CODE
CP10S-□□□-41

- Spacer height
41: 4.1mm (0.161")
- Number of contacts
095 : 95 pin
110 : 110 pin
125 : 125 pin
- Series name
CP10S : Shroud without guide and space for key (Type B)

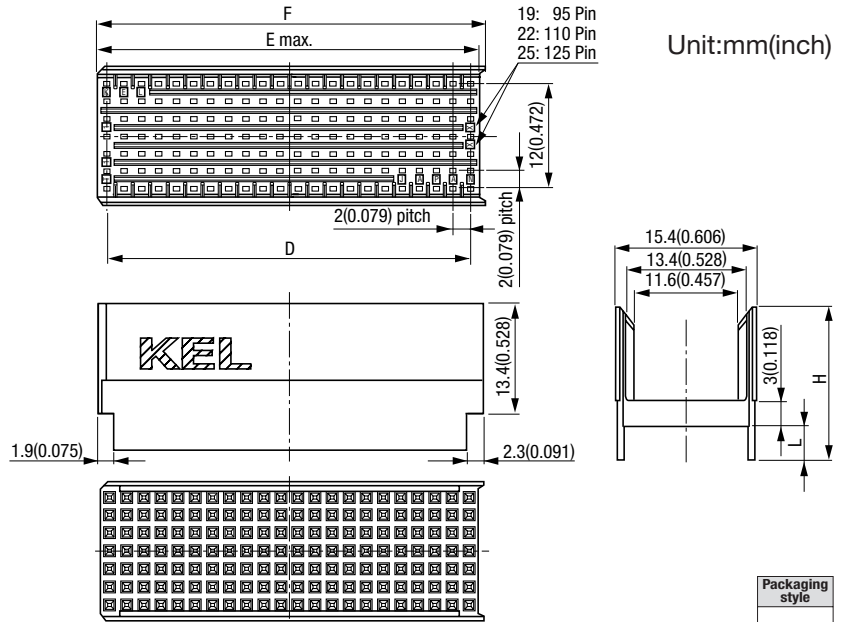

Product Table / Dimensions

No. of contacts	Part Number	D	E	F	H	L	Number of packaging
95	CP10S-095-41	36.00 (1.417)	37.85 (1.490)	38.25 (1.506)	17.50 (0.689)	4.10 (0.161)	180
110	CP10S-110-41	42.00 (1.654)	43.85 (1.726)	44.25 (1.742)	17.50 (0.689)	4.10 (0.161)	150
125	CP10S-125-41	48.00 (1.890)	49.85 (1.963)	50.25 (1.978)	17.50 (0.689)	4.10 (0.161)	120

 Packaging style
Other

CP11S-110-41 (Shroud, Type A)

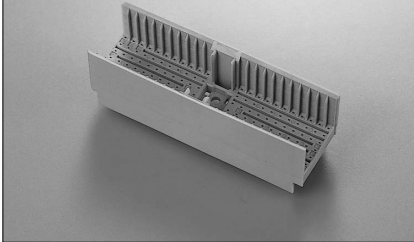
Shroud, Type A

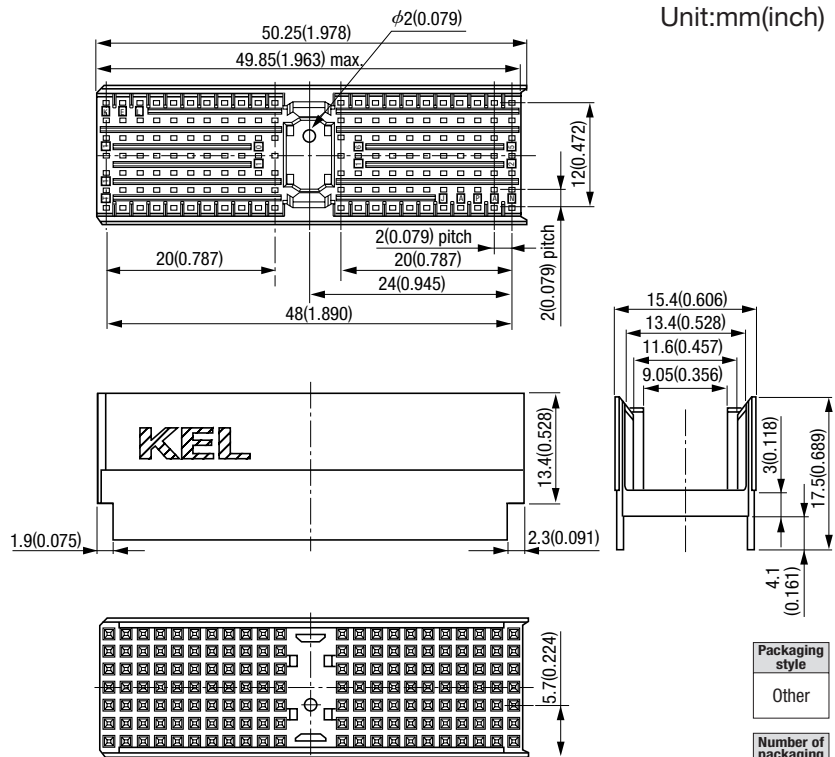

ORDER CODE
CP11S-110-41

- Spacer height
41: 4.1mm (0.161")
- Number of contacts
110 : 110 pin
- Series name
CP11S : Shroud with guide and space for key (Type A, 110 pin only)

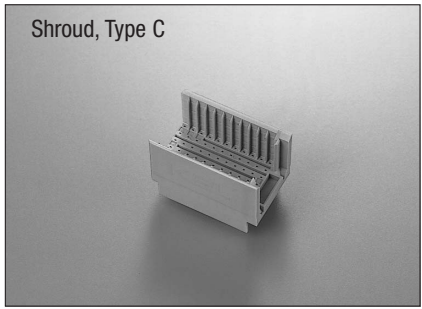

 Packaging style
Other

 Number of packaging
120

CP12S-055-41 (Shroud, 55 pin, Type C)

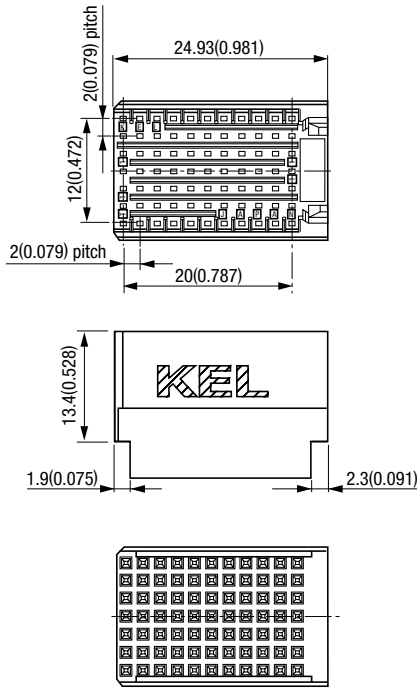

Shroud, Type C



ORDER CODE

CP12S-055-41

- Series name
CP12S : Shroud (Type C, 55 pin only)
- Number of contacts
055 : 55 pin
- Spacer height
41 : 4.1mm (0.161")

Packaging style	Other
Number of packaging	240

CP-K (Coding Key)

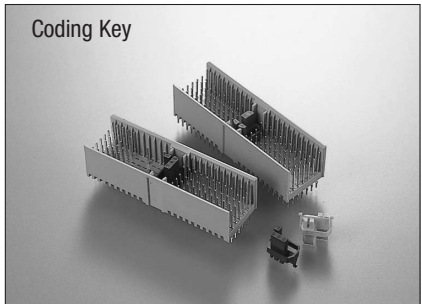

Coding Key

CP0-K (For Receptacle) CP1-K (For Plug)

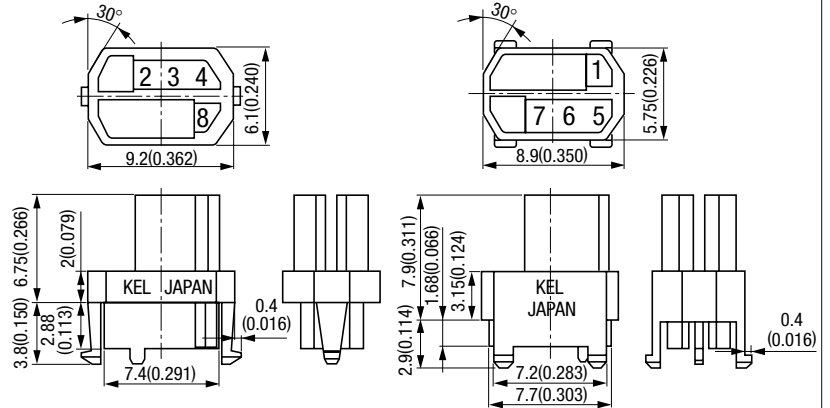

ORDER CODE (Coding Key)

CP-K

- Coding key type
K1 : 5.0V (Color : Brilliant blue)
K2 : 3.3V (Color : Cadmium yellow)
K3 : Computer telephony type, Plug only (Color : Strawberry red)
- Applicable connector
0 : For Receptacle
1 : For Plug
- Series name

CP0-K1 Coding Key-Block Layout CP1-K1 Coding Key-Block Layout



CP0-K2 Coding Key-Block Layout CP1-K2 Coding Key-Block Layout



Packaging style	Other
Number of packaging	100

CP1-K3 Coding Key-Block Layout

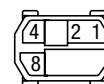

SPECIFICATIONS

- Insulator material : Glass-filled PBT (UL 94V-0)

Connector Installation Tools

Outline for Press-Fit Installation Tool For Plug Connector

This Product requires installation tools to mount on PCB as shown. Both Plug and receptacle connectors can be installed only by replacing "Seating platen and PCB support module" (Other parts are common to both applications). The figure is a composite illustration depicting use of a 3U board type. Please contact your local sales office for further information on the installation tools.

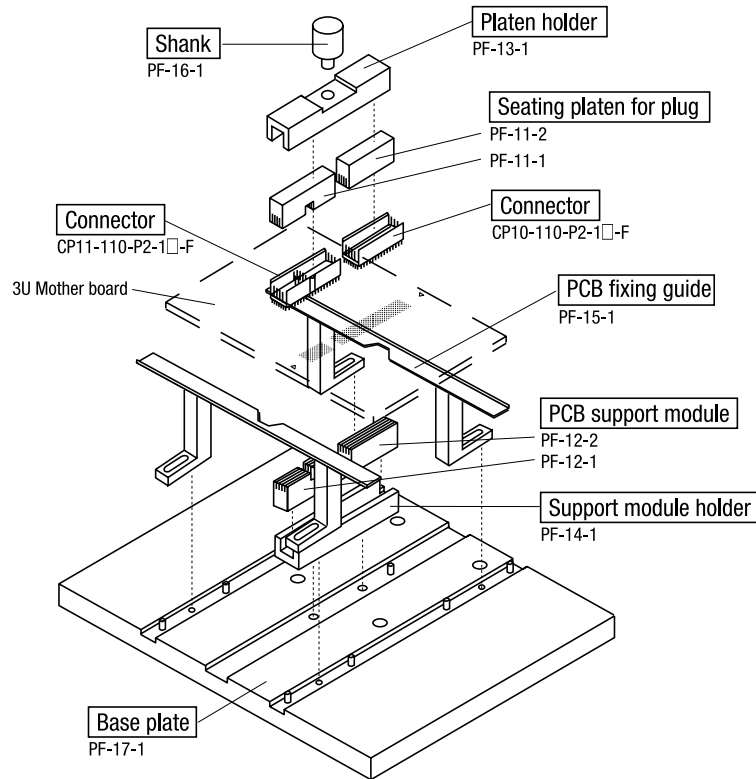

For Receptacle Connector

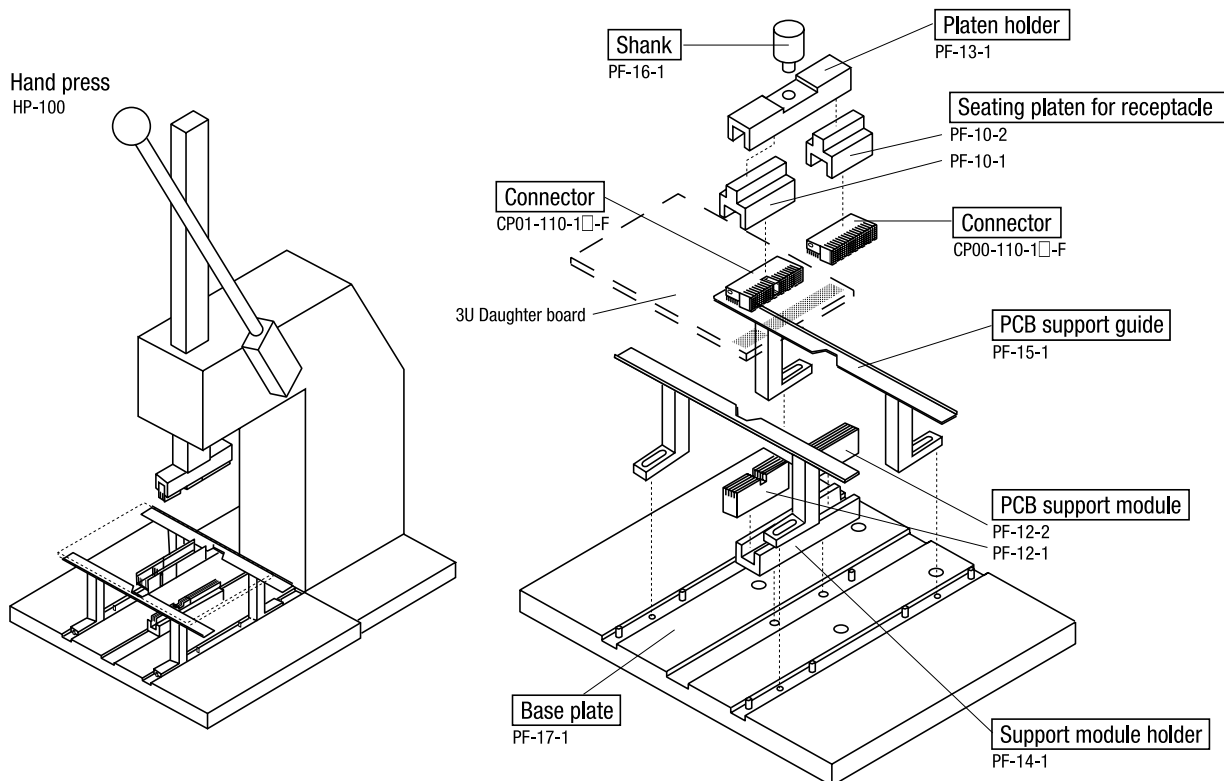

Specifications and dimensions are subject to change without notice.